

H=Altezza sotto gancio
H=Height under hook
H=Hauteur sous crochet

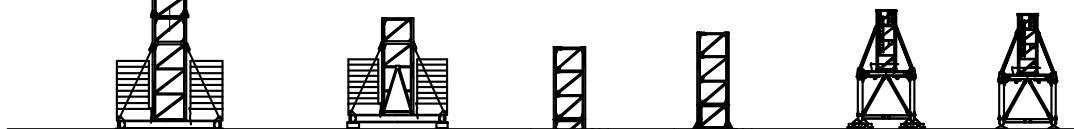

CAF

CATR 
CATC 

TRO

TTD

PRT-TR



PRT

SP2300 - 2.30x2.30 m
SN2050 - 2.05x2.05 m

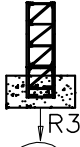
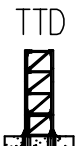
SN2050

Torre/Masts/Mat/Maste/Mästil/Tramo																		
TRO 	H[m]	BFL117	BF117	BF052	BF039	SB117	SB052	SB039	ST117	ST052	ST039	STB117	STB039	RA039	SBB039	SBB117	BFB117	BFB039
		53.3		1	2	2			1			5						
	52		2	1		1			1									
	52		3			1				1								
	52			6			1			3								
*	54.6												5	1	1			7
*	54.6												4	1	1		1	5



H=0–35 m	
R1	135 t
R2	140 t
R3	92 t
M	498 tm

Torre/Masts/Mat/Maste/Mästil/Tramo																		
CAF 	H[m]	BFL117	BF117	BF052	BF039	SB117	SB052	SB039	ST117	ST052	ST039	STB117	STB039	RA039	SBB039	SBB117	BFB117	BFB039
		58.5	1	2	2			1				5						
	57.2	2	1		1			1										
	57.2	3			1					1								
	57.2		6			1				3								
*	59.8												5	1	1			7
*	59.8												4	1	1		1	5

H=35–55 m	
R1	174 t
R2	181 t
R3	119 t
M	637 tm

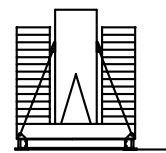
Peso zavorra–Ballast weight–
Ballastgewicht–Peso de lastre



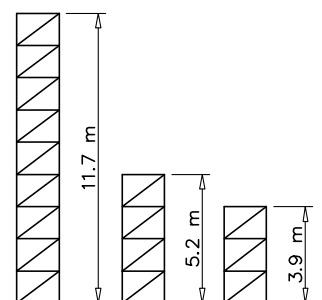

Torre/Masts/Mat/Maste/Mästil/Tramo																		
CATR CATC 	H[m]	BFL117	BF117	BF052	BF039	SB117	SB052	SB039	ST117	ST052	ST039	STB117	STB039	RA039	SBB039	SBB117	BFB117	BFB039
		50.7		3			1					1						
	47.9		2				1				2							
	49.4			5			1			4								
*	52												3	1	1			7
*	52												2	1	1		1	5

H	Tot.
0–35 m	98000 kg
35–55 m	132740 kg





Torre/Reazioni – Masts/Reactions – Mat/Réactions – Maste/Eckdrücke – Mästil/Reacciones – Tramo/Reacções

SP2300

Torre/Masts/Mat/Maste/Mästil/Tramo																			
	H[m]	BFL117	BF117	BF052	BF039	SB117	SB052	SB039	ST117	ST052	ST039	STB117	STB039	RA039	SBB039	SBB117	BFB117	BFB039	
TRO 		4f/4f	4f/4f	4f/4f	4f/4f	4f/4f	4f/4f	4f/4f	4f/4f	4f/4f	4f/4f	4f/4f	4f/4f	4f/4f	4f/4f	4f/4f	4f/4f	4f/4f	4f/4f
	58.5								5										
TTD 	57.2									11									
	41.6								5	4									
	58.5												6	1			1	5	
	58.5												6	1					8



H=0–45 m	
R1	141 t
R2	152 t
R3	128 t
M	775 tm

Torre/Masts/Mat/Maste/Mästil/Tramo																			
	H[m]	BFL117	BF117	BF052	BF039	SB117	SB052	SB039	ST117	ST052	ST039	STB117	STB039	RA039	SBB039	SBB117	BFB117	BFB039	
		4f/4f	4f/4f	4f/4f	4f/4f	4f/4f	4f/4f	4f/4f	4f/4f	4f/4f	4f/4f	4f/4f	4f/4f	4f/4f	4f/4f	4f/4f	4f/4f	4f/4f	4f/4f
	65								5										
CAF 	58.5									10									
	48.1								5	4									
	65												6	1			1	5	
	65												6	1					8

H=45–68 m	
R1	181 t
R2	190 t
R3	160 t
M	973 tm

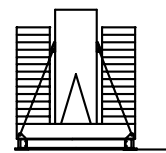
Peso zavorra–Ballast weight–
Ballastgewicht–Peso de lastre

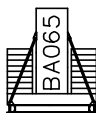

Torre/Masts/Mat/Maste/Mästil/Tramo																			
	H[m]	BFL117	BF117	BF052	BF039	SB117	SB052	SB039	ST117	ST052	ST039	STB117	STB039	RA039	SBB039	SBB117	BFB117	BFB039	
		4f/4f	4f/4f	4f/4f	4f/4f	4f/4f	4f/4f	4f/4f	4f/4f	4f/4f	4f/4f	4f/4f	4f/4f	4f/4f	4f/4f	4f/4f	4f/4f	4f/4f	4f/4f
	57.2								4		1								
CATR CATC 	55.9									8	2								
	40.3									5	2								
	57.2												4	1			1	5	
	57.2												4	1					8

H	Tot.
0–44 m	114000 kg
45–67 m	146000 kg

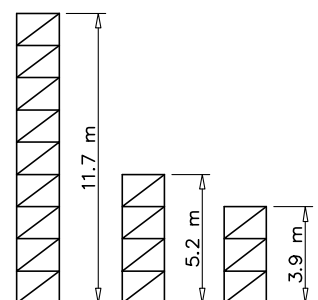



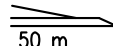
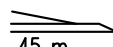
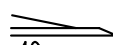

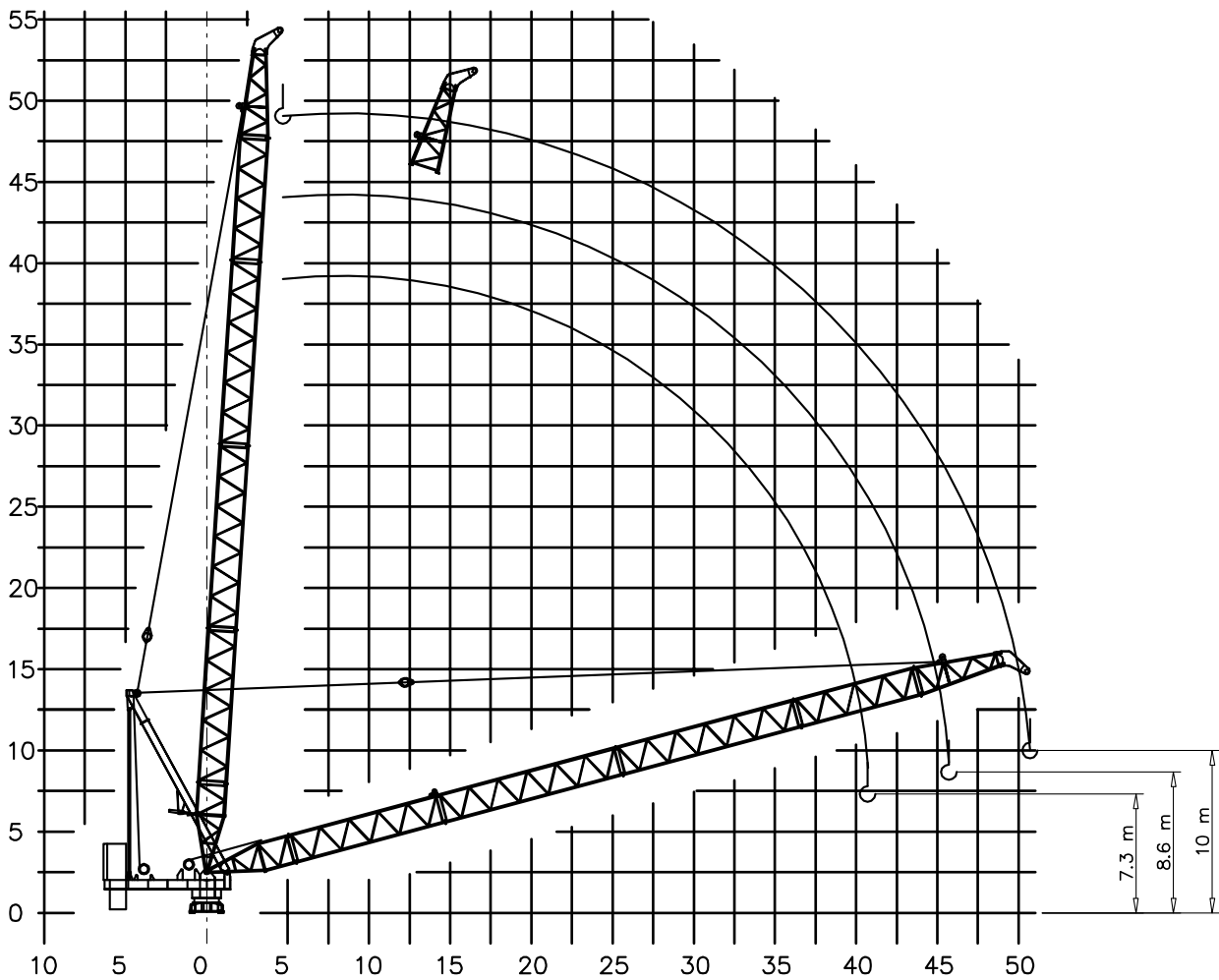

Curve di carico – Courbes de charges – Load diagrams – LastKurven – Curvas de cargas

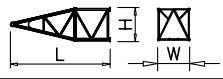

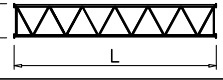
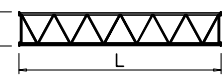
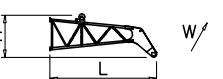
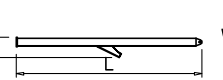

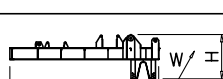

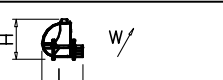
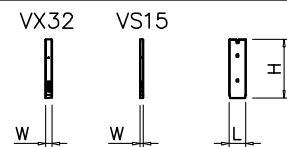

	4.5	16	20	25	30	33	35	40	44	50	m
50 m	12000	12000	7200	6100	5400	4800	4300	3600	3000	2500	kg
	4.5	16	20	25	30	33	35	40	45		m
45 m	12000	12000	7600	6400	5800	5200	4600	3900	3500		kg
	4.5	16	20	25	30	33	35	40			m
40 m	12000	12000	8000	6800	6000	5500	5000	4200			kg

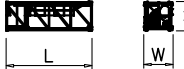

PESI E INGOMBRI – PACKING LIST – LISTE DE COLISAGE – GEWICHT UND ABMESSUNGEN

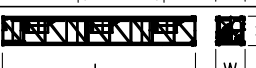
Denominazione Description	Disegno Draw	Pezzi Pieces	Dimensioni-Dimensions (mm)			Peso-Weight (kg)		
			L	W	H	Unit	Total	
Elemento di braccio Jib element Elément de èche Elemento de flecha (50 m. jib version)	1 Jib foot section 		5475	1700	1700	1050	1050	
	2 Intermediate jib section 		9500	1700	1700	1400	2800	
	1 Intermediate jib section 		11350	1700	1700	1513	1513	
	1 Intermediate jib section 		11350	1700	1700	1513	1513	
	1 Jib head 		7000	1700	1700	1840	1840	
	1 Mast 		10800	600	2400	3050	3050	
	1 Mast-tie rod joint 		2000	1800	1000	1150	1150	
	2 Mast tie rod 		1600	300	1800	780	780	
	1 Platform 		7800	1900	2160	7000	7000	
	1 Slewing group 		1750	1750	2200	5800	5800	
Ballatoio con cabina Access balcony with cabin Porte cabine Balcòn corrido con cabina		1	2500	2150	2450	1000	-	
Blocchi contrappeso Counterweight block Contre-poids Bloques de contrapeso	VX32 VS15 	VS15	2	1000	200	3550	1560	3120
		VX32	7	1000	400	3550	3120	21840

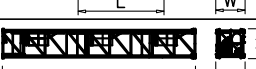
PESI E INGOMBRI – PACKING LIST – LISTE DE COLISAGE – GEWICHT UND ABMESSUNGEN

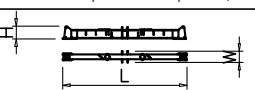
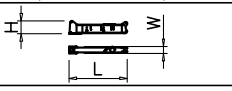
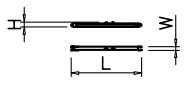
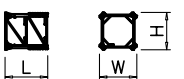
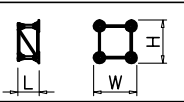
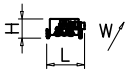
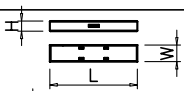
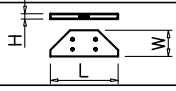
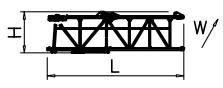
Denominazione Description	Disegno Draw	Pezzi Pieces	Dimensioni-Dimensions (mm)			Peso-Weight (kg)		
			L	W	H	Unit	Total	
Elemento di torre Mast element Elément de mât Elemento de torre	STD039 	SP2300	–	3900	2360	2360	2603	–
		SN2050	–	3900	2110	2110	2320	–
	STD052 	SP2300	–	5200	2360	2360	3198	–
		SN2050	–	5200	2110	2110	2850	–
	STD117 	SP2300	–	11700	2360	2360	6475	–
		SN2050	–	11700	2110	2110	5790	–
	SB039 	SP2300	–	3900	2360	2360	3031	–
		SN2050	–	3900	2110	2110	2710	–
	SB052 	SP2300	–	5200	2360	2360	3470	–
		SN2050	–	5200	2110	2110	3350	–
SB117 	SP2300	–	11700	2360	2360	7830	–	
	SN2050	–	11700	2110	2110	7000	–	
BF039 	SP2300	–	3900	2360	2360	4210	–	
	SN2050	–	3900	2110	2110	3770	–	
BF052 	SP2300	–	5200	2360	2360	4340	–	
	SN2050	–	5200	2110	2110	3880	–	
BF117 	SP2300	–	11700	2360	2360	9150	–	
	SN2050	–	11700	2110	2110	8180	–	
Elemento di base Base element Mat de base Elemento de base	BA052 	SP2300	1	5200	2360	2360	4220	–
		SN2050	1	5200	2260	2260	4040	–
Carro di base Base carriage Chassis de base Cruceta de base		8x8	1	11830	670	780	3340	3340
		6x6	1	8870	670	780	2500	2500
		8x8	2	5760	420	780	1600	3200
		6x6	2	4320	420	780	1200	2400
Puntoni di base Rafter Jambes de force Cabrios de base		8x8	4	6080	420	300	560	2240
		6x6	4	4560	420	300	420	1680
Elemento a perdere Disposable frame Chassis a perdre Bastidor desechable		SP2300	1	3000	2360	2360	2350	–
		SN2050	1	2600	2260	2260	2030	–
Elemento recuperabile Recoverable frame Chassis récupérable Bastidor recuperable		SP2300	1	1300	2900	2900	2100	–
		SN2050	1	1300	2620	2620	1860	–
Bogie di traslazione Driven bogie Boggie motorisèe Balancin de traslaciòn		4	1160	700	600	700	2800	
Blocco zavorra di base Base ballast block Lest de base Bloque de lastre		8x8	2	8300	1200	600	11900	23800
		6x6	2	6400	1200	600	10600	21200
		8x8	–	6400	1600	300	5700	–
		6x6	–	4800	2000	300	5070	–
Corsoio di montaggio Climbing cage Cage de montage Jaula de montaje		SP2300	1	8300	3250	3000	7500	–
		SN2050	1	8300	2900	2700	6700	–

GRU IN CAVEDIO – TELESCOPAGE SUR DALLES – CLIMBING CRANE – KLETTERKRANE IM GEBAUDE

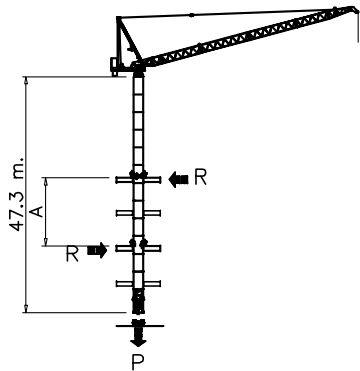

SN2050	H (m)	A (m)	R (t)	P (t)
	9	45.3	120	
	10	42		
	11	39.3		
	12	37		
	13	35		
	14	33.4		
	15	32		

* SOPRALZO IDRAULICO – TELESCOPABLE – EXTERNAL CLIMBING – KLETTERKRANE

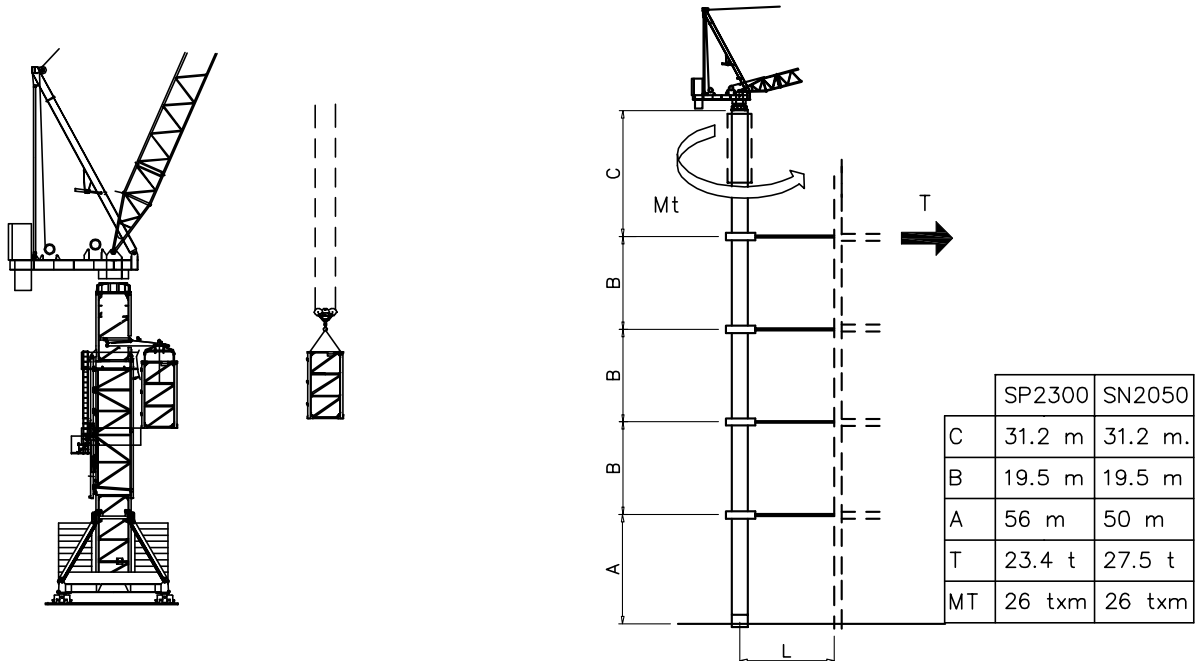

Montaggio – Montage – Erection – Montage – Montaje – Montagem

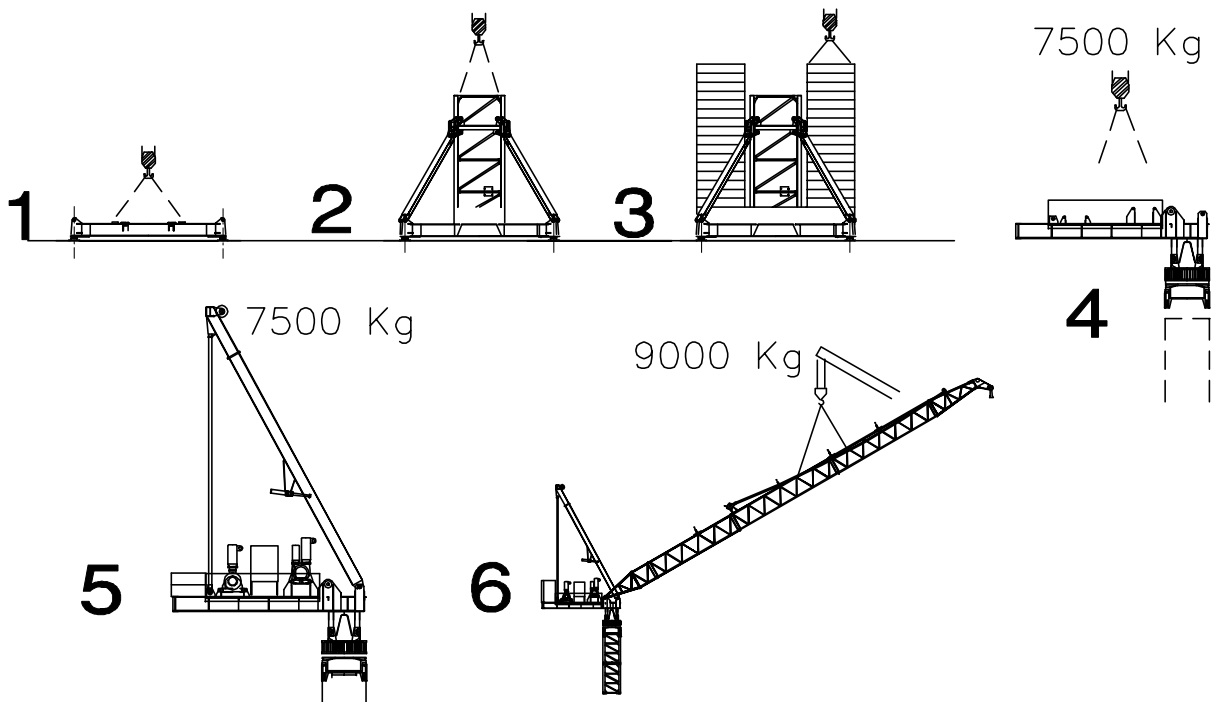

Sollevamento V100.100 Hoisting Levage Heben Elevaciòn Elevaçao														V100.100 75 kW 110 kVA 360 m 750 m (L)
	m/min	18	38	60	96	128	150	9	19	30	48	64	75	
	t	6	6	6	4	2.6	1.3	12	12	12	8	5.2	2.6	

Impennamento braccio Luffing jib Flèche relevée Ausleger in steilstellung Flecha izada Lança inclinada			0 → 5	min	75 kW	Potenza elettrica necessaria Puissance électrique nécessaire Necessary electric power Anschlusswert – Potencia
Rotazione Slewing Orientation Schwenken Orientaciòn Rotaçao			0 → 0,9	giri/min tr/min rp/min	6.6 kW @ 1200rpm n° 3 x 2.2 kW	
Traslazione Travelling Translation Kranfahren Traslaciòn Translaçao			0 → 20	m/min	9 kW	

Rete elettrica – Réseau – Mains supply – Netzstrom – Red – Rede electrica	400V – 50 Hz
---	--------------

FMgru s.r.l. via Emilia 11-29010 Pontenure PC ITALY tel. 0523/510446 ric.aut. fax 0523/510365 www.fmgru.it e-mail: info@fmgru.com
--

FEM 1.001 2000/14/CE



Documento commerciale non contrattuale
Per tutte le informazioni tecniche riferirsi
alle corrispondenti istruzioni

Unverbindliches Vertriebsdokument.
Für technische Informationen, siehe die
entsprechenden Anweisungen.

This commercial document is not legally
binding. For any technical information, please
refer to the corresponding instructions.

Documento comercial no contractual
Para cualquier información técnica,
ver la noticia correspondiente.

Code: 15/CA37L35A0		
Ed.	Data	Rev Data
1	24.03.10	0 24.03.10